

DOG JUMPING COMPETITION REGULATIONS



1. This competition is a test of the dog's jumping ability.
2. The competition is open to all dogs.
3. The dog is permitted to jump on to or over the jump.
4. A dog who has won at Show Society level will qualify for the State Final Judging. A dog can represent only ONE Society. State Final is held at Ballarat Show in November each year.
5. Each Society conducting this competition must supply to V.A.S.L. in writing immediately following the Show:
 - Name of the winning dog in each Section.
 - Height jumped by winning dog in each Section.
 - Owners Name, address, phone number and email address of winning dog in each Section.
6. All dogs not competing must be on a lead with a handler in the Marshalling Area behind the competition area. Competition area should be 15 metres long by 8 metres wide.
7. Only ONE dog may be loose in the competition area at any one time.
8. Every dog must compete at every height.
9. There must be a handler at the top of the jump to act as a catcher if necessary, and a handler as a catcher at the bottom. The dog's owner must supply the extra handler.
10. Each dog is allowed three attempts at each height if necessary.
11. In the event of two dogs jumping the same height, the winner shall be determined as the dog that took the least number of attempts from one jump.
12. A dog may compete on a loose lead or must be released at a minimum of three metres from the jump.
13. ANY MISHANDLING OR MISUSE OF A DOG WILL INCUR IMMEDIATE DISQUALIFICATION.
14. If, in the opinion of the Stewards, a dog is unsafe to other competitors or the general public, it will be withdrawn from the Competition.
15. The Jumps should be constructed according to the following specifications:-

The top must be a minimum of 600mm wide and covered with carpet or some such material. Construction and dimensions see diagram attached.
16. Classes
 - Small dog class under 50 cms.
 - Medium dog class 50 cms and less than 60 cms.
 - Large dog class 60 cms and over.
17. If, since competing at a local Show, a dog which has won in any of the classes has grown in height, that dog must compete in the appropriate class at the State Final.
18. A ladder will be provided for the handler.

DRW No 1 DOG JUMP (HIGH)

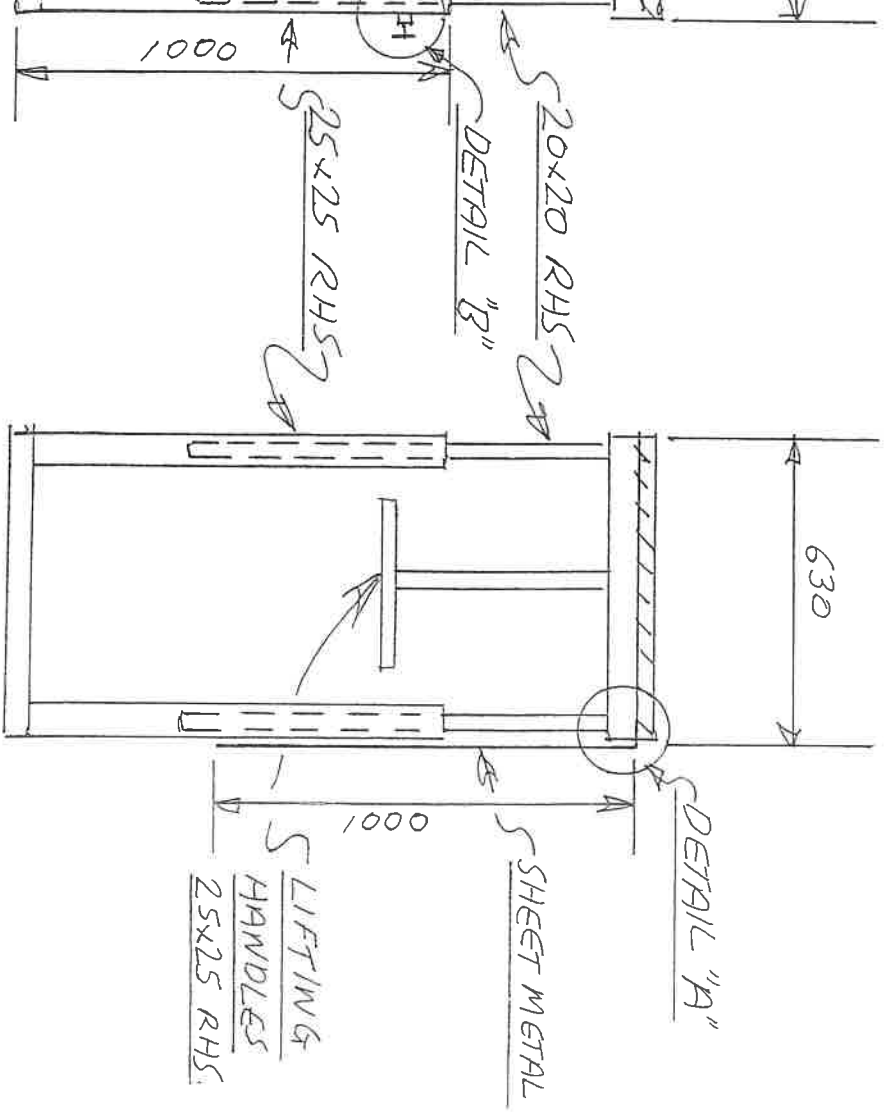
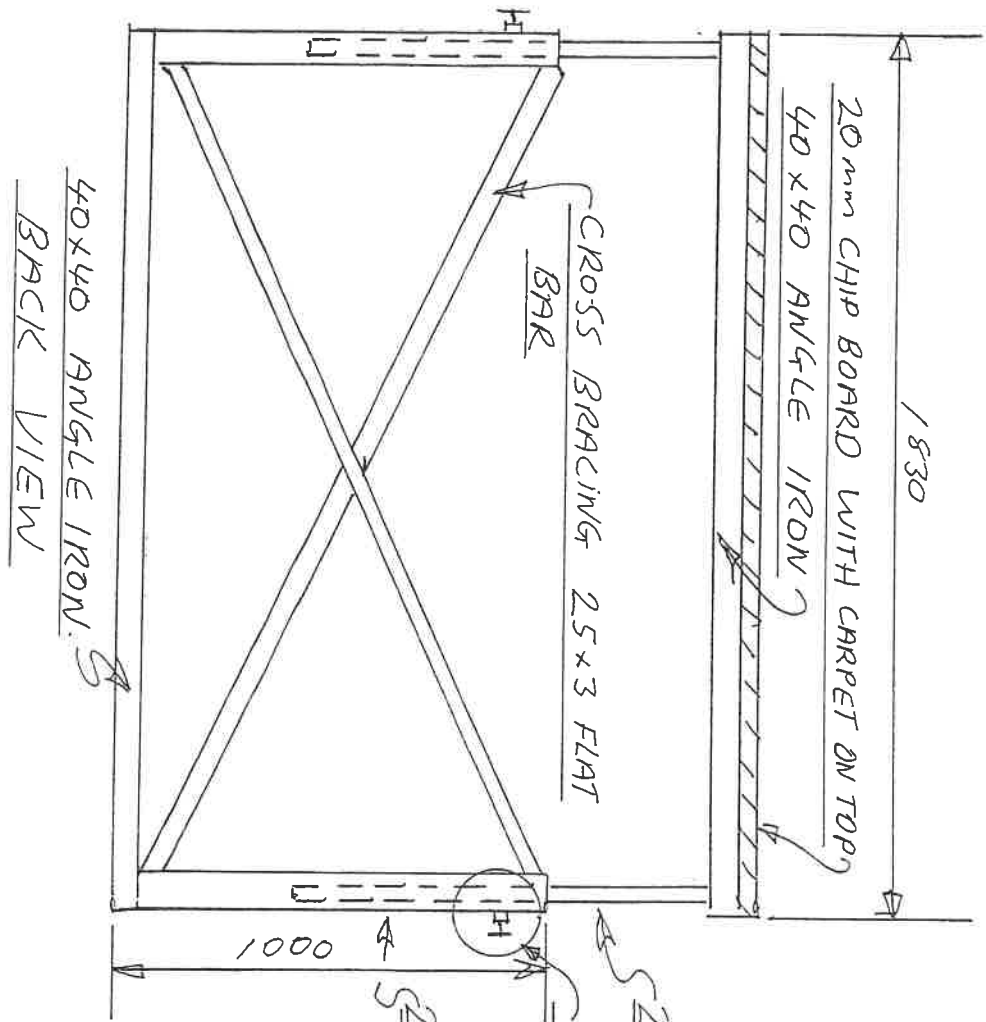

DRW No 2 DOG JUMP (LOW)

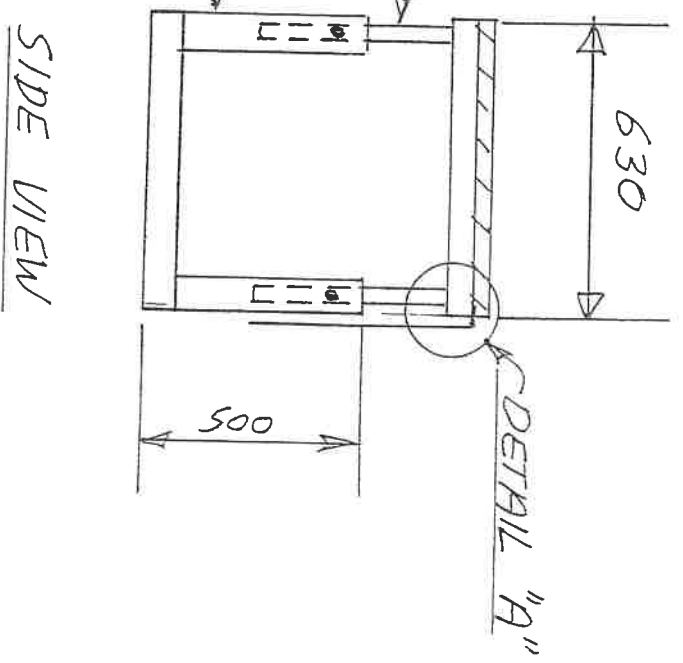
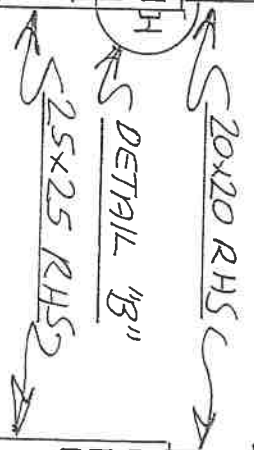
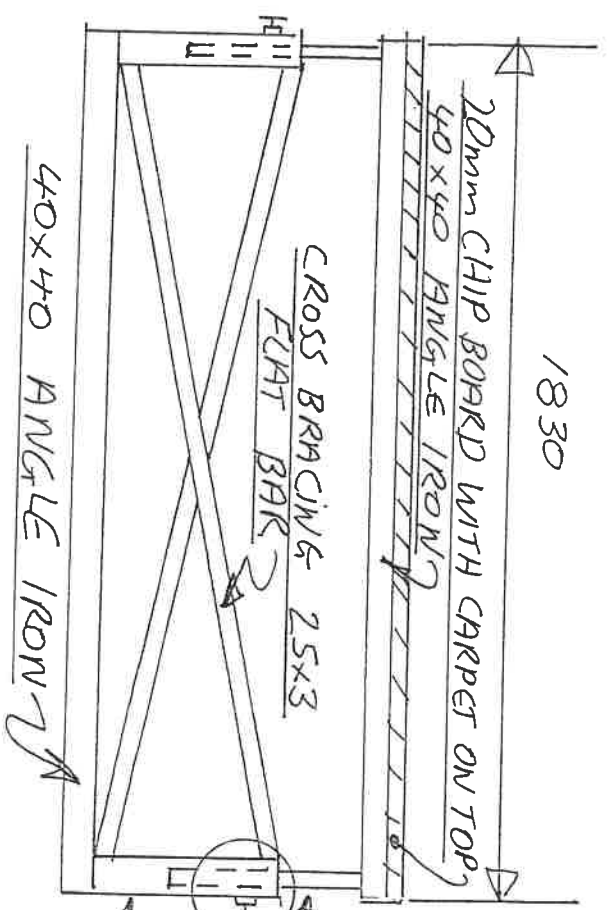

DRW No 3 DETAIL "A" + "B"

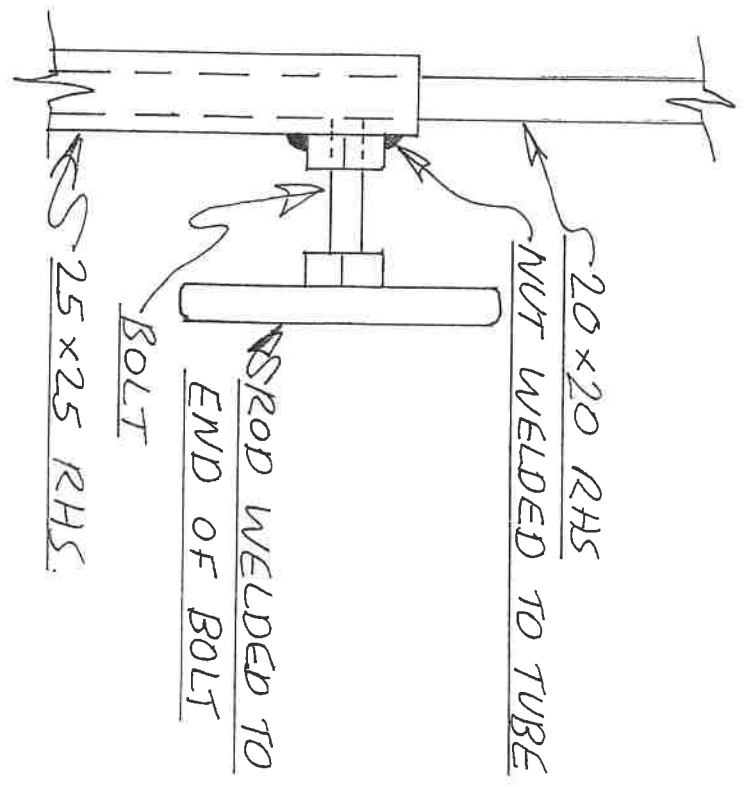

DETAIL "B"

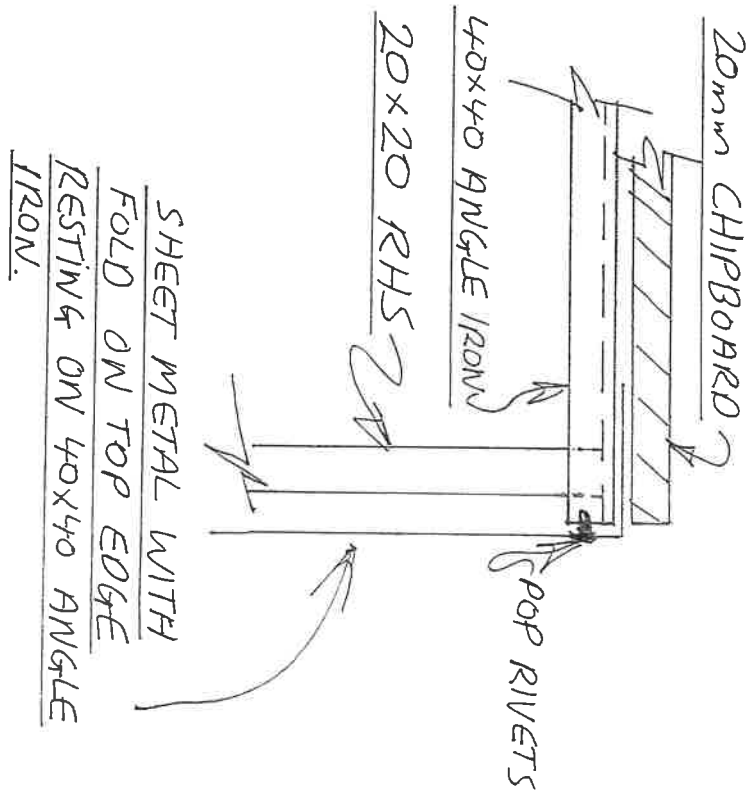

DETAIL "A"